

PRODUCT TECHNICAL DATASHEET

R93/RX2RC/U



CODE	DESCRIPTION	PCS/PALLET
R93/RX2RC/U	Terminal receiver rolling code, 2 channels 433,92 Mhz (1000 storable codes) with plastic box.	

PRODUCT TECHNICAL SPECIFICATIONS

Standard power	12/24V AC/DC
Absorption	30mA
Operating temperature	-10+55°C
Number of channels	2
Codification	Rolling Code
Modulation	AM/ASK
Carried frequency	433.92 Mhz
Relay contacts max current	0.5A
Relay contacts max voltage	24V AC/DC
Exit	Relay
Storable codes	250/1000
Sensibility	-107 dBm
Input impedance	50
Maximum dimension product in mm (L x W x H)	126 x 52 x 25
Product weight packed (Kg)	0,1

PRODUCT DIMENSIONS AND PREPARING FOR INSTALLATION

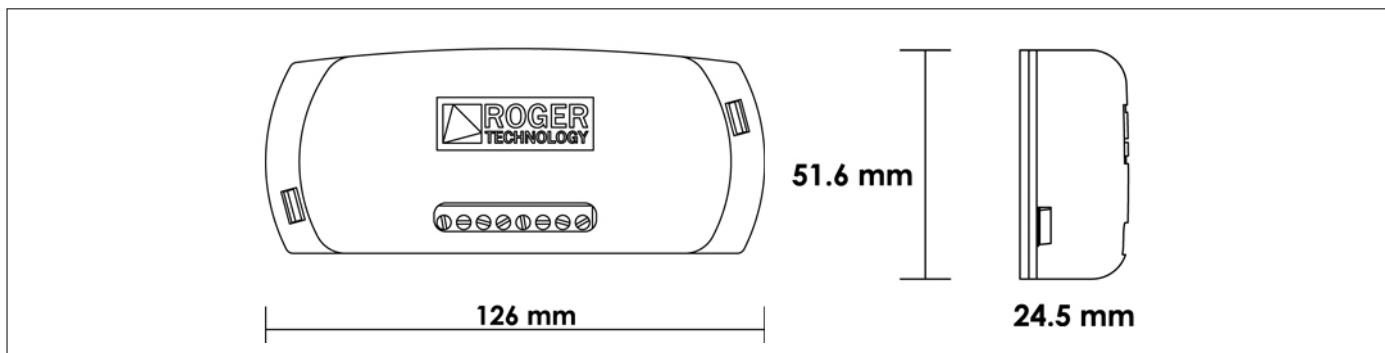

DIMENSIONS